

# Data Sheet



Article number: 07109303001

Description: Universal joint double 0.109.303.001  
S=228 X= Bore 35 H7 with keyway

## Measures

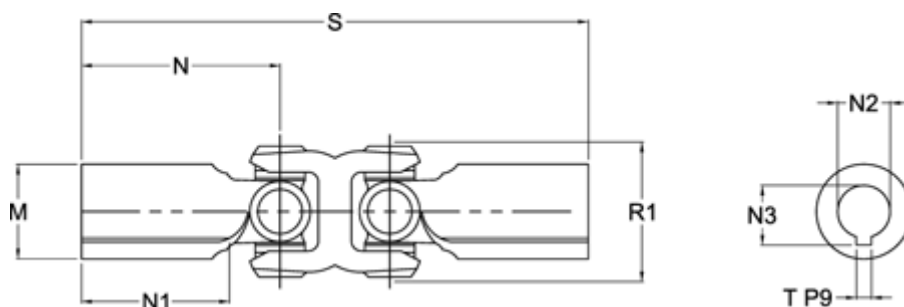

M	= 57	T = 10 P9
Max. Bending Angle degrees	= 20	
N	= 80	
N1	= 50	
N2	= 35 H7	
N3	= 38,3 +0,2	
R1	= 86	
S min	= 228	